



# NAE03S03-B (EN42MDED) DC-DC Converter

## Technical Manual

Issue V1.0  
Date 2019-06-04

HUAWEI TECHNOLOGIES CO., LTD.



## About This Document

### Purpose

This document describes the NAE03S03-B (EN42MDED) in terms of its physical structure, electrical characteristics, and simple application.

The figures provided in this document are for reference only.





### Intended Audience

This document is intended for:

- Hardware engineers
- Software engineers
- System engineers
- Technical support engineers

### Symbol Conventions

The symbols that may be found in this document are defined as follows.

Symbol	Description
	Indicates an imminently hazardous situation which, if not avoided, will result in death or serious injury.
	Indicates a potentially hazardous situation which, if not avoided, could result in death or serious injury.
	Indicates a potentially hazardous situation which, if not avoided, may result in minor or moderate injury.
	Indicates a potentially hazardous situation which, if not avoided, could result in equipment damage, data loss, performance deterioration, or unanticipated results. NOTICE is used to address practices not related to personal injury.
	Calls attention to important information, best practices and tips. NOTE is used to address information not related to personal injury, equipment damage, and environment deterioration.

## Change History

Changes between document issues are cumulative. The latest document issue contains all updates made in previous issues.

### **Issue 1.0 (2019-06-04)**

This issue is the first official release.

## Contents

<b>About This Document.....</b>	<b>i</b>
<b>1 Product Overview.....</b>	<b>1</b>
<b>2 Electrical Specifications.....</b>	<b>5</b>
2.1 Absolute Maximum Ratings.....	5
2.2 Input Characteristics.....	5
2.3 Output Characteristics.....	6
2.4 Protection.....	7
2.5 Dynamic Characteristics.....	7
2.6 Efficiency.....	8
2.7 Other Characteristics.....	9
<b>3 Characteristic Curves.....</b>	<b>11</b>
3.1 Test Setup Diagram & Fundamental Circuit Diagram.....	11
3.2 Efficiency and Power Dissipation Curves.....	12
3.3 Thermal Considerations.....	15
3.4 Turn-on/Turn-off.....	17
3.5 Output voltage ripple.....	19
3.6 Input reflected ripple current.....	19
3.7 Output Voltage Dynamic Response.....	20
<b>4 Control Features.....</b>	<b>21</b>
4.1 Remote On/Off.....	21
4.2 Output Voltage Trim.....	21
4.3 Power Good Signal (PG).....	22
4.4 Voltage Tracking (SS).....	23
<b>5 Protection Features.....</b>	<b>24</b>
<b>6 Qualification Testing.....</b>	<b>25</b>
<b>7 Thermal Consideration.....</b>	<b>27</b>
<b>8 Encapsulation Size Diagram.....</b>	<b>28</b>
<b>9 Package Information.....</b>	<b>29</b>
<b>10 Mechanical Consideration.....</b>	<b>30</b>

# 1 Product Overview

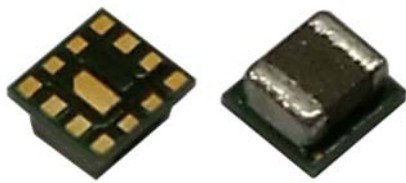

The NAE03S03-B is a Power System in Package (PSiP) DC-DC converter with an input voltage range of 3 V to 5.75 V and the maximum output current of 3 A. Its output voltage can be adjusted within a range of 0.8 V to 3.7 V.

#### Mechanical Features

- SMT
- Length: 3.0 mm (0.12 in.); width: 2.8 mm (0.11 in.); maximum height: 1.6 mm (0.06 in.)
- Weight: 0.1 g

#### Control Features

- Remote on/off
- Output voltage trim

#### Model Naming Convention

NAE	03	S	03	-	B
1	2	3	4		5

1 — Non-isolated, analog, package type

2 — Input voltage: 3.3 V

3 — Single output

#### Operational Features

- Input voltage: 3 – 5.75 V
- Output current: 0 – 3 A
- Output voltage: 0.8 – 3.7 V
- Efficiency: 93.5% ( $V_{in} = 3.3$  V,  $V_{out} = 2.5$  V,  $I_{out} = 1.5$  A)

#### Protection Features

- Input undervoltage protection
- Output overcurrent protection (hiccup mode)
- Output short circuit protection (hiccup mode)
- Overtemperature protection (self-recovery)

#### Environmental Protection

- RoHS6 complaint, lead-free reflow soldering

#### Applications

- Servers
- Telecom and datacom
- Point of load regulation
- General purpose step-down DC/DC

4 — Output current: 3 A

5 — Extension code

### Mechanical Diagram

Figure 1-1 Mechanical diagram

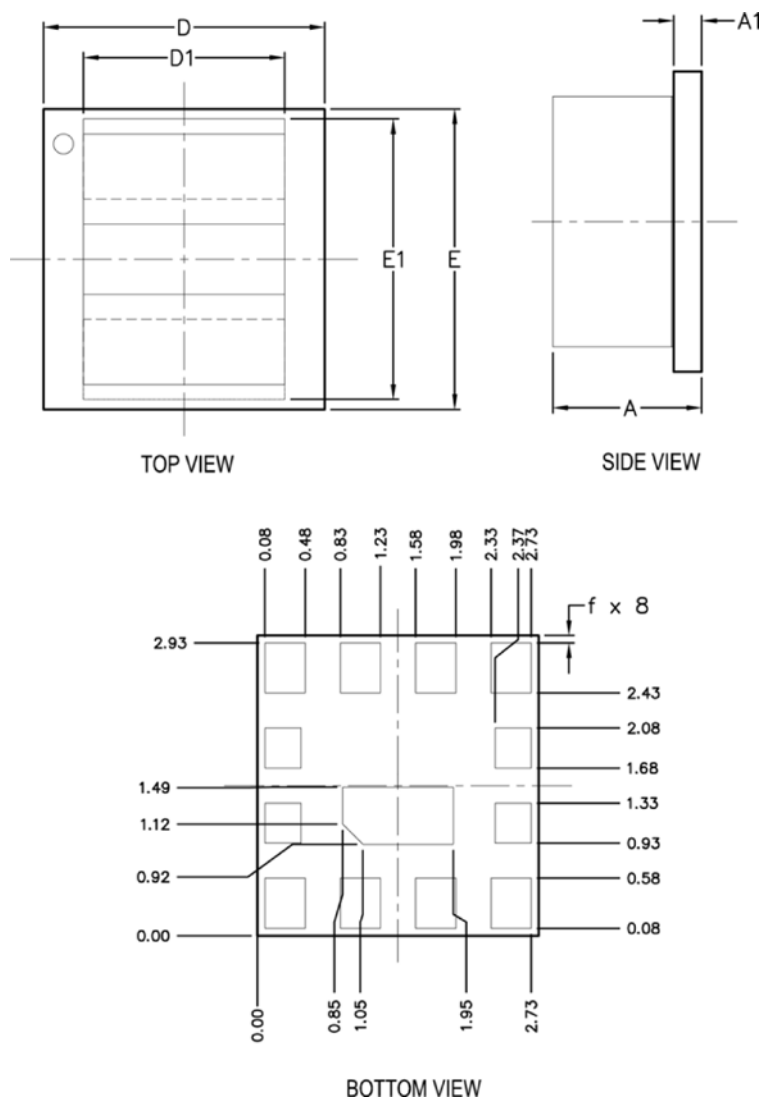

Symbol	Min. (mm)	Typ. (mm)	Max. (mm)
A	-	-	1.60
A1	0.25	0.29	0.33
D	2.70	2.80	2.90

Symbol	Min. (mm)	Typ. (mm)	Max. (mm)
D1	1.95	2.00	2.05
E	2.90	3.00	3.10
E1	2.45	2.50	2.55
f	0.01	0.06	0.11

### NOTE

1. All dimensions in mm [in.]. Tolerances:  $x.x \pm 0.1$  mm [ $x.xx \pm 0.03$  in.];  $x.xx \pm 0.05$  mm [ $x.xxx \pm 0.002$  in.];  $x.xxx \pm 0.050$  mm [ $x.xxx \pm 0.002$  in.].
2. Angles tolerance:  $\pm 1^\circ$

Figure 1-2 Pin Description

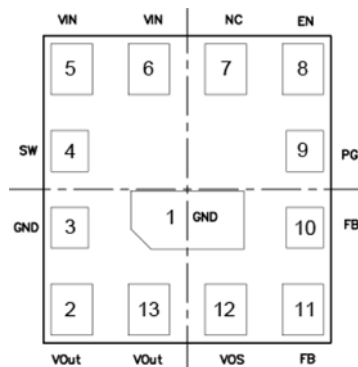

Table 1-1 Pin description

Pin No.	Name	Function
1, 3	GND	Input and output power ground. Connect these pins to the ground electrode of the input and output filter capacitors.
2, 13	V <sub>out</sub>	Output pins. Connect these pins to loads and place output filter capacitors between these pins and GND pins.
4	SW	Switching node of the circuit. This pin is used to check the switching frequency.
5, 6	V <sub>in</sub>	Power input pins. Connect these pins to input power supply and place input filter capacitors between these pins and GND pins.

# NAE03S03-B DC-DC Converter

## Technical Manual

1 Product Overview

Pin No.	Name	Function
7	NC	Not connected: These pins must be soldered to PCB but not electrically connected to each other or to any external signal, voltage, or ground. These pins may be connected internally. Failure to follow this guideline may result in device damage.
8	EN	Enable pin. A high level enables the converter while a low level disables the converter. For details, see Remote On/Off (EN).
9	PG	Power good signal. This is an open-drain signal. The pull-up resistor can not be connected to any voltage higher than 6 V. If unused, leave it floating.
10, 11	FB	Output adjustment pin. A resistor divider connecting the feedback to the GND is used to set the desired output voltage.
12	VOS	Output voltage sense pin. This pin is connected to FB through a resistor.



# 2 Electrical Specifications

## 2.1 Absolute Maximum Ratings

Parameter	Min.	Typ.	Max.	Unit	Notes & Conditions
Input voltage (continuous)	-	-	7	V	-
Operating ambient temperature (T <sub>A</sub> )	- 40	-	85	°C	When the input voltage is 7V/10ms, the converter must not be damaged. Not all the characteristic parameters should be conform to the specification. When BMP module do overvoltage test, the module cannot be damaged.
Storage temperature	- 55	-	125	°C	-
Operating humidity	10	-	95	% RH	Non-condensing
External voltage applied to On/Off	-	-	5	V	-

## 2.2 Input Characteristics

Parameter	Min.	Typ.	Max.	Unit	Notes & Conditions
Operating input voltage	3.00	3.30	5.75	V	-
Maximum input current	-	-	6	A	V <sub>in</sub> = 0 - 5.75 V; I <sub>out</sub> = I <sub>onom</sub>
No-load loss	-	0.2	-	W	V <sub>in</sub> = 5.0 V; I <sub>out</sub> = 0 A
Input capacitance	20	-	-	μF	Ceramic capacitor
Inrush transient	-	-	6	A	-

## 2.3 Output Characteristics

Parameter	Min.	Typ.	Max.	Unit	Notes & Conditions
Output voltage setpoint	- 2.0	-	2.0	% $V_{oset}$	$V_{in} = 3.3 \text{ V}$ ; $I_{out} = 50\%I_{onom}$ ; Tested with 0.1% tolerance for external resistor used to set output voltage
Output voltage	0.8	-	3.7	V	$V_{in} - V_{out} \geq 0.5 \text{ V}$
Output current	0	-	3	A	-
Line regulation	- 0.5	-	0.5	%	$V_{in} = 3 - 5.75 \text{ V}$ ; $I_{out} = I_{onom}$
Load regulation	- 1	-	1	%	$V_{in} = 3.3 \text{ V}$ ; $I_{out} = I_{omin} - I_{onom}$
Regulated voltage precision	- 3	-	3	%	$V_{in} = 3 - 5.75 \text{ V}$ ; $I_{out} = I_{omin} - I_{onom}$
Temperature coefficient	- 0.02	-	0.02	%/°C	$T_A = -40^\circ\text{C}$ to $+85^\circ\text{C}$
External capacitance	22	-	322	$\mu\text{F}$	Ceramic capacitor; $V_{in} - V_{out} > 0.8 \text{ V}$
	44	-	322	$\mu\text{F}$	Ceramic capacitor; $V_{in} - V_{out} \leq 0.8 \text{ V}$
Output ripple and noise (peak to peak)	-	5	10	mV	$V_{out} \leq 1.5 \text{ V}$ , $I_{out} > 10\%I_{onom}$ Oscilloscope bandwidth: 20 MHz
	-	10	15	mV	$V_{out} \leq 1.5 \text{ V}$ , $I_{out} \leq 10\%I_{onom}$ Oscilloscope bandwidth: 20 MHz
	-	-	20	mV	$1.5 \text{ V} < V_{out} \leq 2.5 \text{ V}$ Oscilloscope bandwidth: 20 MHz
	-	-	30	mV	$2.5 \text{ V} < V_{out} \leq 3.7 \text{ V}$ Oscilloscope bandwidth: 20 MHz
Output voltage overshoot	-	-	5	%	Full range of $V_{in}$ , $I_{out}$ , and $T_A$
Output voltage rise time	-	0.8	2	ms	From 10% $V_{out}$ to 90% $V_{out}$

Parameter	Min.	Typ.	Max.	Unit	Notes & Conditions
Switching frequency	-	2400	-	kHz	$I_{out} = 1\text{ A}$

## 2.4 Protection

Table 2-1 Input Protection

Parameter	Min.	Typ.	Max.	Unit	Notes & Conditions
Input undervoltage protection threshold	1.9	2.2	2.4	V	-
Input undervoltage protection recovery threshold	2.1	2.4	2.6	V	-
Input undervoltage protection hysteresis	-	0.2	-	V	-

Table 2-2 Output Protection

Parameter	Min.	Typ.	Max.	Unit	Notes & Conditions
Output overcurrent protection	110	-	200	%	Hiccup mode
Output short circuit protection	-	-	-	-	Hiccup mode
Overtemperature protection threshold	-	150	-	°C	Self-recovery
Overtemperature protection hysteresis	-	20	-	°C	Self-recovery

## 2.5 Dynamic Characteristics

Parameter	Min.	Typ.	Max.	Unit	Notes & Conditions
Overshoot amplitude	-	5	-	% $V_{out}$	Current change rate: 5 A/ $\mu$ s Load: 25% - 50% - 25%; 50% - 75% - 50%
Overshoot amplitude recovery time	-	100	-	$\mu$ s	

## 2.6 Efficiency

Parameter	Min.	Typ.	Max.	Units	Notes & Conditions
20% load	68.5	70	-	%	$V_{in} = 3.3\text{ V}; V_{out} = 0.8\text{ V}; T_A = 25^\circ\text{C}$
	71	72.5	-	%	$V_{in} = 3.3\text{ V}; V_{out} = 0.9\text{ V}; T_A = 25^\circ\text{C}$
	73.5	75	-	%	$V_{in} = 3.3\text{ V}; V_{out} = 1.0\text{ V}; T_A = 25^\circ\text{C}$
	78.5	80	-	%	$V_{in} = 3.3\text{ V}; V_{out} = 1.2\text{ V}; T_A = 25^\circ\text{C}$
	83.5	85	-	%	$V_{in} = 3.3\text{ V}; V_{out} = 1.5\text{ V}; T_A = 25^\circ\text{C}$
	86	87.5	-	%	$V_{in} = 3.3\text{ V}; V_{out} = 1.8\text{ V}; T_A = 25^\circ\text{C}$
	89.5	91	-	%	$V_{in} = 3.3\text{ V}; V_{out} = 2.5\text{ V}; T_A = 25^\circ\text{C}$
50% load	70.0	81.5	-	%	$V_{in} = 3.3\text{ V}; V_{out} = 0.8\text{ V}; T_A = 25^\circ\text{C}$
	81.0	82.5	-	%	$V_{in} = 3.3\text{ V}; V_{out} = 0.9\text{ V}; T_A = 25^\circ\text{C}$
	82.5	84.0	-	%	$V_{in} = 3.3\text{ V}; V_{out} = 1.0\text{ V}; T_A = 25^\circ\text{C}$
	84.0	85.5	-	%	$V_{in} = 3.3\text{ V}; V_{out} = 1.2\text{ V}; T_A = 25^\circ\text{C}$
	86.5	88.0	-	%	$V_{in} = 3.3\text{ V}; V_{out} = 1.5\text{ V}; T_A = 25^\circ\text{C}$
	88.0	89.5	-	%	$V_{in} = 3.3\text{ V}; V_{out} = 1.8\text{ V}; T_A = 25^\circ\text{C}$
	92.0	93.5	-	%	$V_{in} = 3.3\text{ V}; V_{out} = 2.5\text{ V}; T_A = 25^\circ\text{C}$
100% load	69.5	71.0	-	%	$V_{in} = 3.3\text{ V}; V_{out} = 0.8\text{ V}; T_A = 25^\circ\text{C}$
	71.0	72.5	-	%	$V_{in} = 3.3\text{ V}; V_{out} = 0.9\text{ V}; T_A = 25^\circ\text{C}$
	73.0	74.5	-	%	$V_{in} = 3.3\text{ V}; V_{out} = 1.0\text{ V}; T_A = 25^\circ\text{C}$
	76.0	77.5	-	%	$V_{in} = 3.3\text{ V}; V_{out} = 1.2\text{ V}; T_A = 25^\circ\text{C}$
	79.0	80.5	-	%	$V_{in} = 3.3\text{ V}; V_{out} = 1.5\text{ V}; T_A = 25^\circ\text{C}$
	82.0	83.5	-	%	$V_{in} = 3.3\text{ V}; V_{out} = 1.8\text{ V}; T_A = 25^\circ\text{C}$
	86.5	88.0	-	%	$V_{in} = 3.3\text{ V}; V_{out} = 2.5\text{ V}; T_A = 25^\circ\text{C}$
20% load	59.5	61	-	%	$V_{in} = 5.0\text{ V}; V_{out} = 0.8\text{ V}; T_A = 25^\circ\text{C}$
	63.5	65	-	%	$V_{in} = 5.0\text{ V}; V_{out} = 0.9\text{ V}; T_A = 25^\circ\text{C}$
	65.5	67	-	%	$V_{in} = 5.0\text{ V}; V_{out} = 1.0\text{ V}; T_A = 25^\circ\text{C}$
	70.5	72	-	%	$V_{in} = 5.0\text{ V}; V_{out} = 1.2\text{ V}; T_A = 25^\circ\text{C}$

Parameter	Min.	Typ.	Max.	Units	Notes & Conditions
	75.5	77	-	%	$V_{in} = 5.0\text{ V}; V_{out} = 1.5\text{ V}; T_A = 25^\circ\text{C}$
	78.5	80	-	%	$V_{in} = 5.0\text{ V}; V_{out} = 1.8\text{ V}; T_A = 25^\circ\text{C}$
	83.5	85	-	%	$V_{in} = 5.0\text{ V}; V_{out} = 2.5\text{ V}; T_A = 25^\circ\text{C}$
	91.0	92.5	-	%	$V_{in} = 5.0\text{ V}; V_{out} = 3.3\text{ V}; T_A = 25^\circ\text{C}$
50% load	78.5	80.0	-	%	$V_{in} = 5.0\text{ V}; V_{out} = 0.8\text{ V}; T_A = 25^\circ\text{C}$
	79.5	81.0	-	%	$V_{in} = 5.0\text{ V}; V_{out} = 0.9\text{ V}; T_A = 25^\circ\text{C}$
	80.5	82.0	-	%	$V_{in} = 5.0\text{ V}; V_{out} = 1.0\text{ V}; T_A = 25^\circ\text{C}$
	83.0	84.5	-	%	$V_{in} = 5.0\text{ V}; V_{out} = 1.2\text{ V}; T_A = 25^\circ\text{C}$
	85.0	86.5	-	%	$V_{in} = 5.0\text{ V}; V_{out} = 1.5\text{ V}; T_A = 25^\circ\text{C}$
	86.5	88.0	-	%	$V_{in} = 5.0\text{ V}; V_{out} = 1.8\text{ V}; T_A = 25^\circ\text{C}$
	89.0	90.5	-	%	$V_{in} = 5.0\text{ V}; V_{out} = 2.5\text{ V}; T_A = 25^\circ\text{C}$
	91.0	92.5	-	%	$V_{in} = 5.0\text{ V}; V_{out} = 3.3\text{ V}; T_A = 25^\circ\text{C}$
100% load	70.0	71.5	-	%	$V_{in} = 5.0\text{ V}; V_{out} = 0.8\text{ V}; T_A = 25^\circ\text{C}$
	72.0	73.5	-	%	$V_{in} = 5.0\text{ V}; V_{out} = 0.9\text{ V}; T_A = 25^\circ\text{C}$
	74.0	75.5	-	%	$V_{in} = 5.0\text{ V}; V_{out} = 1.0\text{ V}; T_A = 25^\circ\text{C}$
	76.5	78.0	-	%	$V_{in} = 5.0\text{ V}; V_{out} = 1.2\text{ V}; T_A = 25^\circ\text{C}$
	79.5	81.0	-	%	$V_{in} = 5.0\text{ V}; V_{out} = 1.5\text{ V}; T_A = 25^\circ\text{C}$
	81.5	83.0	-	%	$V_{in} = 5.0\text{ V}; V_{out} = 1.8\text{ V}; T_A = 25^\circ\text{C}$
	85.0	86.5	-	%	$V_{in} = 5.0\text{ V}; V_{out} = 2.5\text{ V}; T_A = 25^\circ\text{C}$
	88.0	89.5	-	%	$V_{in} = 5.0\text{ V}; V_{out} = 3.3\text{ V}; T_A = 25^\circ\text{C}$

## 2.7 Other Characteristics

Parameter	Min.	Typ.	Max.	Unit	Notes & Conditions
Remote On/Off voltage low level	- 0.2	-	0.5	V	Positive logic
Remote On/Off voltage high level	2.0	-	5.0	V	

# NAE03S03-B DC-DC Converter

## Technical Manual

2 Electrical Specifications

Parameter	Min.	Typ.	Max.	Unit	Notes & Conditions
PG high threshold (FB from low to high)	92	95	99	% V <sub>ref</sub>	-
PG low threshold (FB from high to low)	87	90	94	% V <sub>ref</sub>	-
Mean time between failures (MTBF)	-	2.5	-	Million hours	Telcordia, SR332 Method 1 Case 3; 80% load; normal input; rated output; airflow rate = 1.5 m/s (300 LFM); T <sub>A</sub> = 40°C

# 3 Characteristic Curves

## 3.1 Test Setup Diagram & Fundamental Circuit Diagram

Figure 3-1 Test setup diagram

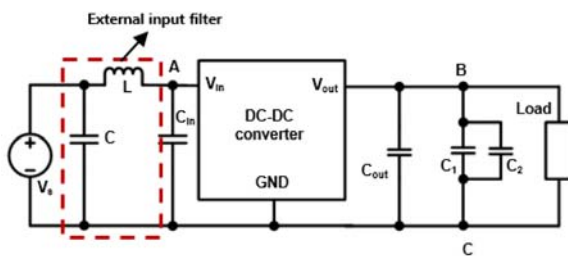

$C_{in}$ : The 20  $\mu\text{F}$  ceramic capacitor is recommended.

$C_{out}$ :  $V_{in} - V_{out} > 0.8 \text{ V}$ , the 22  $\mu\text{F}$  ceramic capacitor is recommended;  $V_{in} - V_{out} \leq 0.8 \text{ V}$ , the 44  $\mu\text{F}$  ceramic capacitor is recommended.

$C_1$ : The 0.1  $\mu\text{F}$  ceramic capacitor is recommended.

$C_2$ : The 10  $\mu\text{F}$  aluminum electrolytic capacitor is recommended.

Figure 3-2 Application circuit

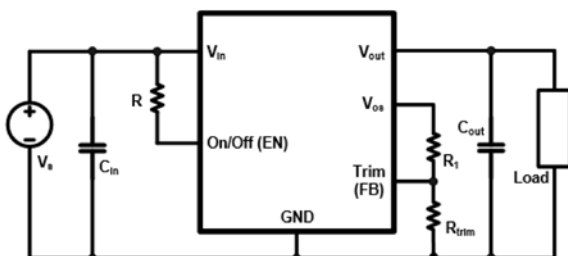

$R, R_1$ : 20  $\text{k}\Omega$

$C_{in}$ : The 20  $\mu\text{F}$  ceramic capacitor is recommended.

$C_{out}$ :  $V_{in} - V_{out} > 0.8\text{ V}$ , the  $22\ \mu\text{F}$  ceramic capacitor is recommended;  $V_{in} - V_{out} \leq 0.8\text{ V}$ , the  $44\ \mu\text{F}$  ceramic capacitor is recommended.

#### NOTE

1. During the test of input reflected ripple current, the input must be connected to an external input filter (including a  $12\ \mu\text{H}$  inductor and a  $220\ \mu\text{F}$  electrolytic capacitor), which is not required in other tests.
2. Points B and C, which are used for testing the output voltage ripple, are  $25\text{ mm}$  ( $0.98\text{ in.}$ ) away from the  $V_{out}(+)$  pin and the  $V_{out}(-)$  pin, respectively.

## 3.2 Efficiency and Power Dissipation Curves

Conditions:  $T_A = 25^\circ\text{C}$ , unless otherwise specified

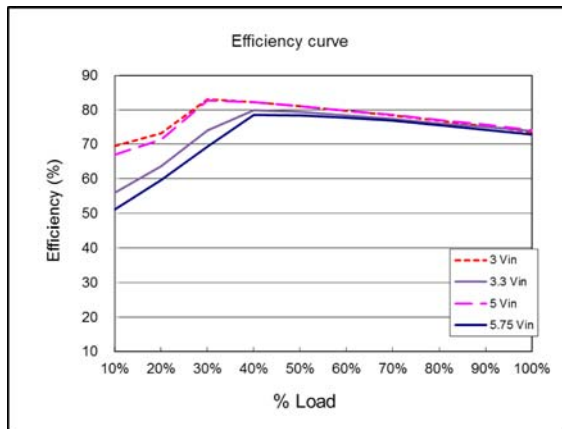

Efficiency curve ( $V_{out} = 0.8\text{ V}$ )

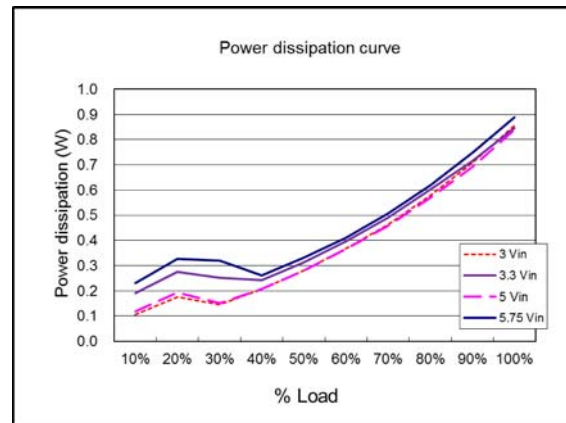

Power dissipation curve ( $V_{out} = 0.8\text{ V}$ )

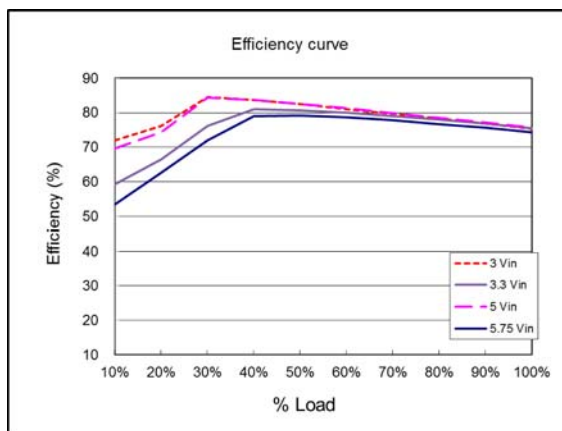

Efficiency curve ( $V_{out} = 0.9\text{ V}$ )

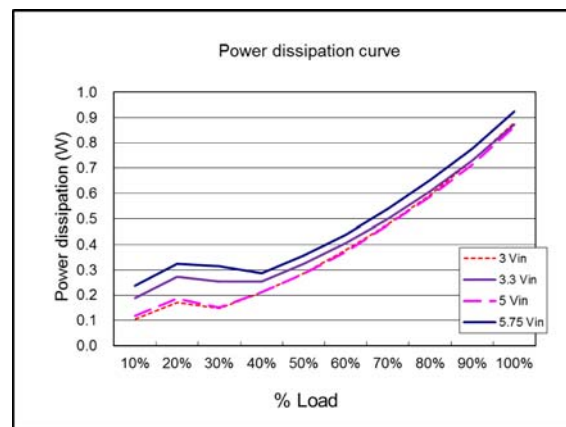

Power dissipation curve ( $V_{out} = 0.9\text{ V}$ )



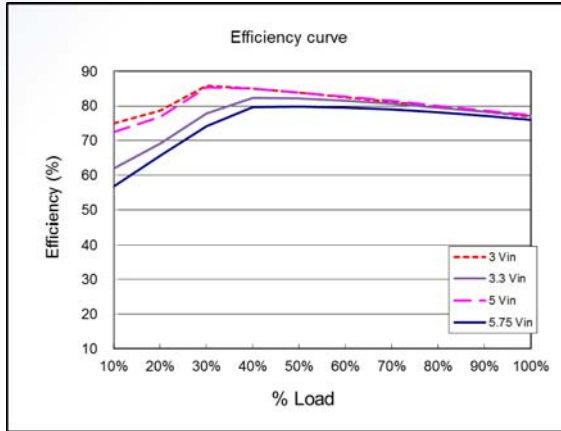

Efficiency curve ( $V_{out} = 1.0\text{ V}$ )

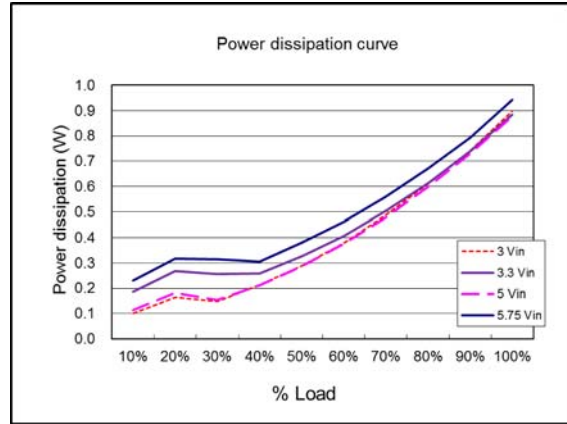

Power dissipation curve ( $V_{out} = 1.0\text{ V}$ )

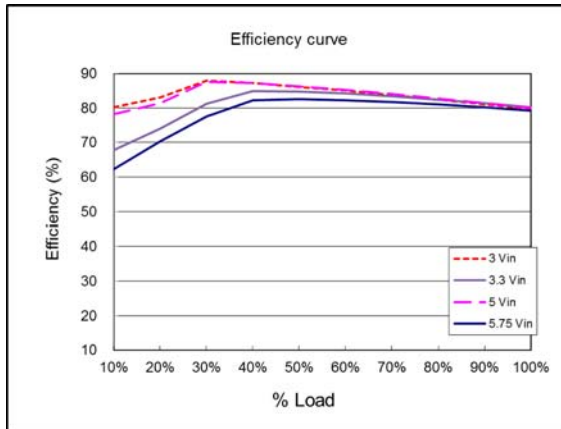

Efficiency curve ( $V_{out} = 1.2\text{ V}$ )

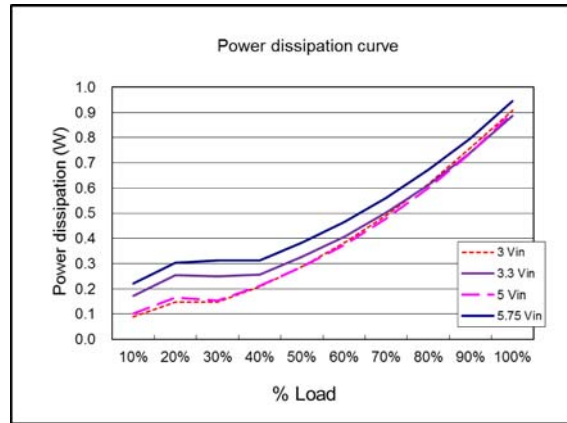

Power dissipation curve ( $V_{out} = 1.2\text{ V}$ )

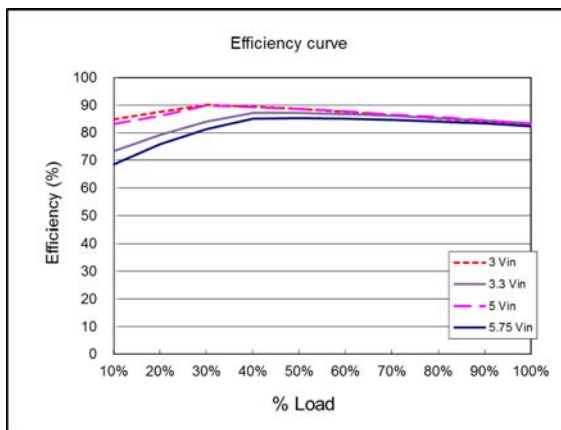

Efficiency curve ( $V_{out} = 1.5\text{ V}$ )

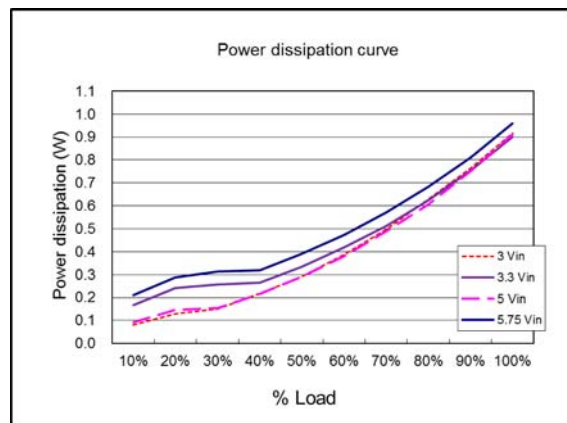

Power dissipation curve ( $V_{out} = 1.5\text{ V}$ )

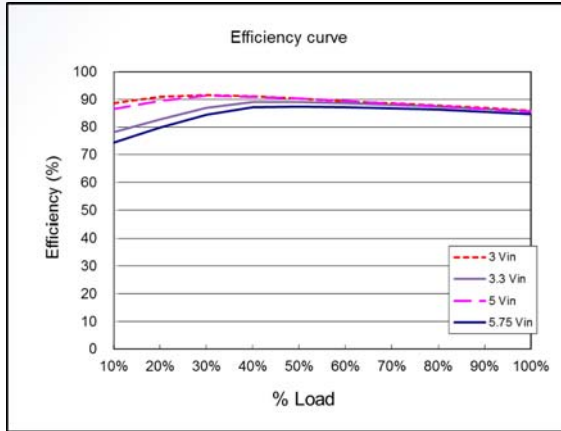

Efficiency curve ( $V_{out} = 1.8\text{ V}$ )

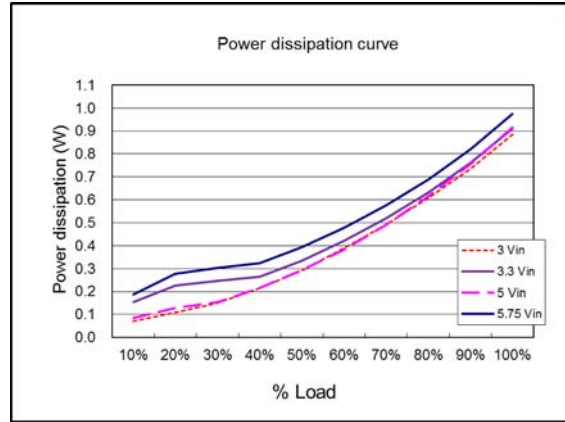

Power dissipation curve ( $V_{out} = 1.8\text{ V}$ )

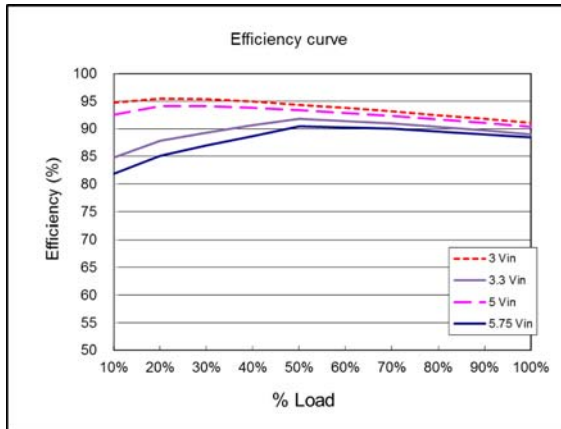

Efficiency curve ( $V_{out} = 2.5\text{ V}$ )

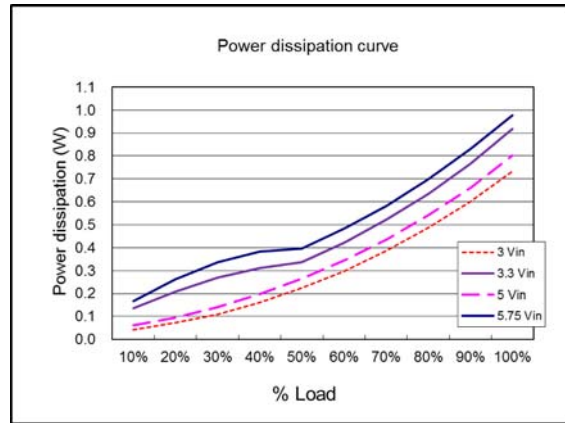

Power dissipation curve ( $V_{out} = 2.5\text{ V}$ )

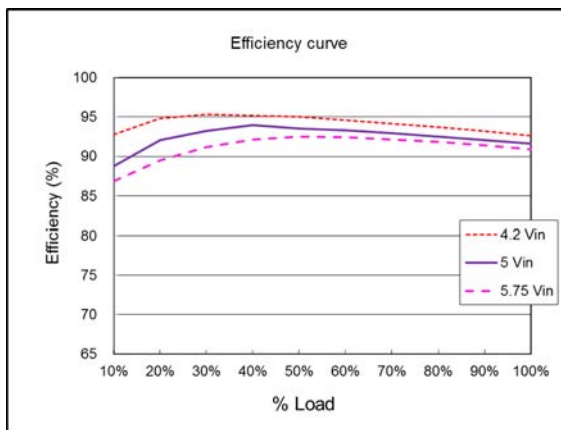

Efficiency curve ( $V_{out} = 3.3\text{ V}$ )

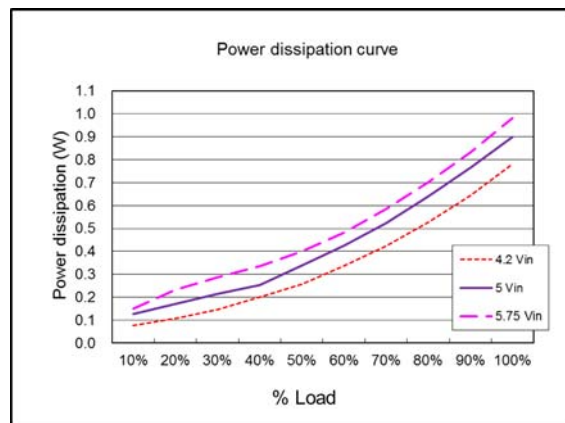

Power dissipation curve ( $V_{out} = 3.3\text{ V}$ )

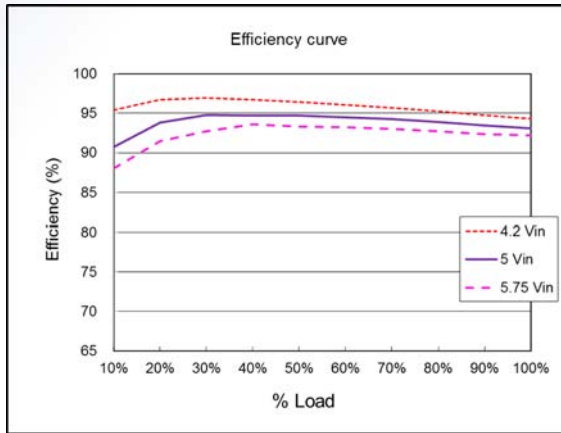

Efficiency curve ( $V_{out} = 3.7V$ )

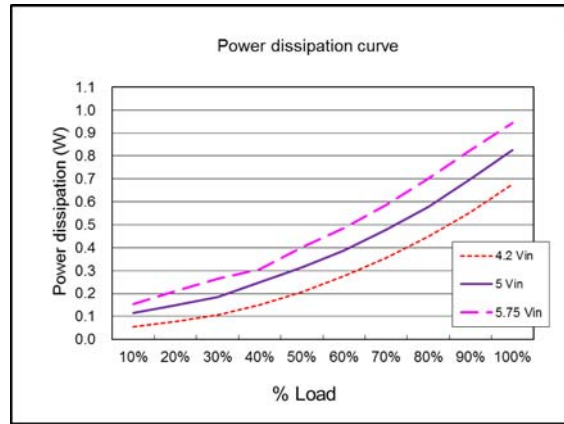

Power dissipation curve ( $V_{out} = 3.7V$ )

### 3.3 Thermal Considerations

Conditions:  $T_A = 25^\circ C$ , unless otherwise specified

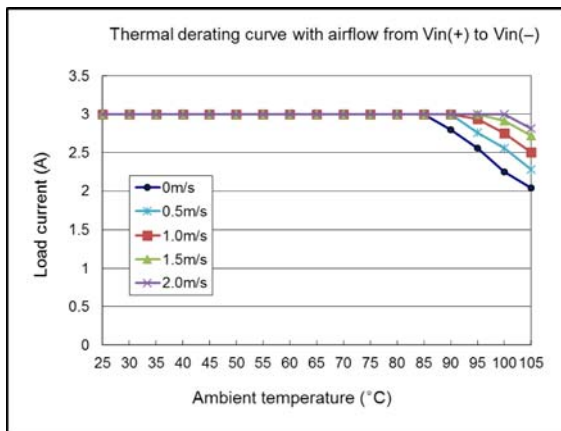

Thermal derating with airflow from  $V_{in}(+)$  to  $V_{in}(-)$  ( $V_{in} = 5V$ ;  $V_{out} = 3.7V$ )

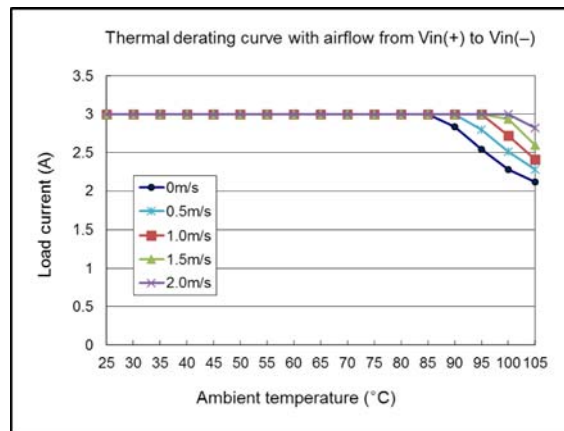

Thermal derating with airflow from  $V_{in}(+)$  to  $V_{in}(-)$  ( $V_{in} = 5V$ ;  $V_{out} = 3.3V$ )

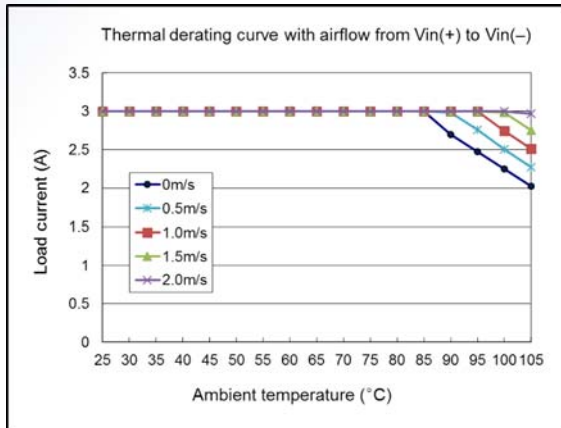

Thermal derating with airflow from  $V_{in}(+)$  to  $V_{in}(-)$   
( $V_{in} = 5\text{ V}$ ;  $V_{out} = 2.5\text{ V}$ )

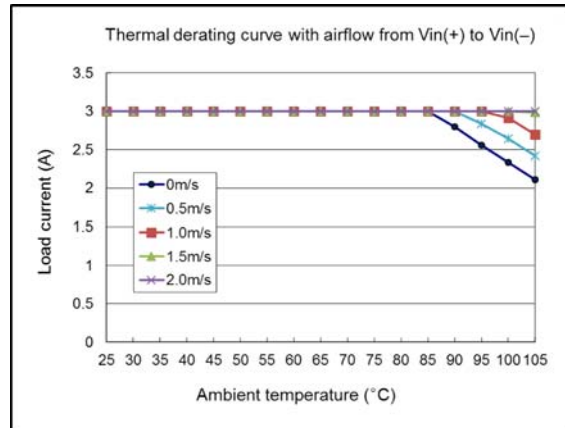

Thermal derating with airflow from  $V_{in}(+)$  to  $V_{in}(-)$   
( $V_{in} = 5\text{ V}$ ;  $V_{out} = 1.8\text{ V}$ )

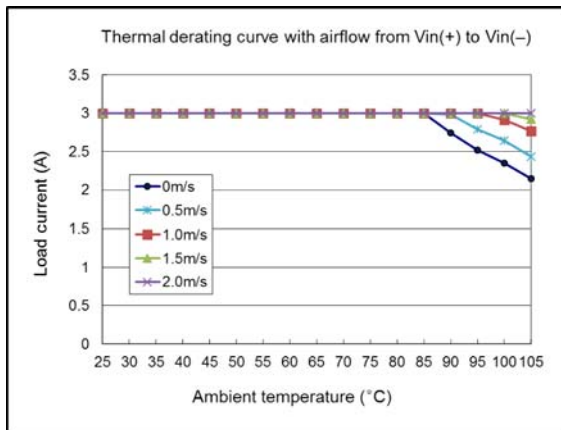

Thermal derating with airflow from  $V_{in}(+)$  to  $V_{in}(-)$   
( $V_{in} = 3.3\text{ V}$ ;  $V_{out} = 2.5\text{ V}$ )

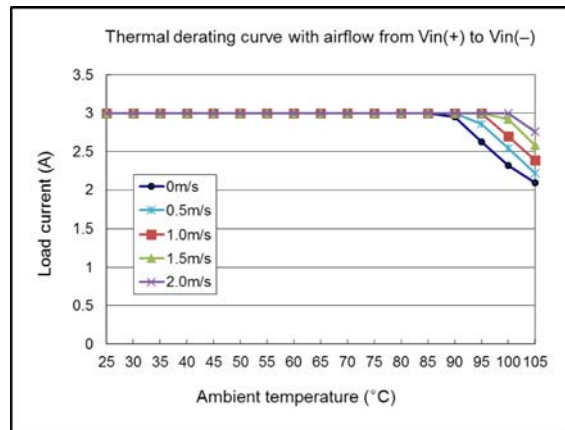

Thermal derating with airflow from  $V_{in}(+)$  to  $V_{in}(-)$   
( $V_{in} = 3.3\text{ V}$ ;  $V_{out} = 1.8\text{ V}$ )

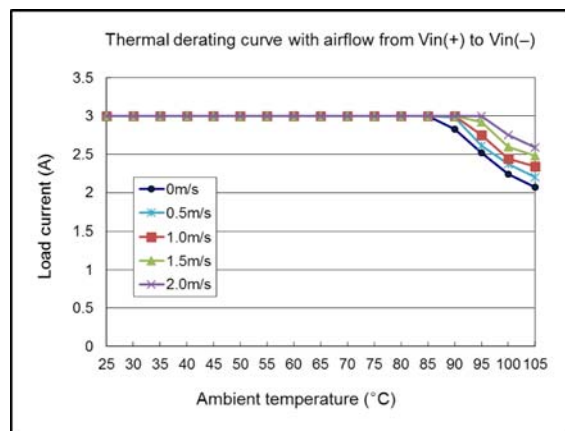
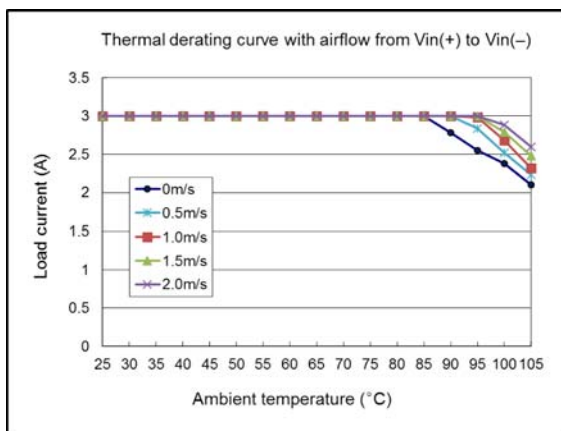

Thermal derating with airflow from  $V_{in}(+)$  to  $V_{in}(-)$   
 ( $V_{in} = 3.3\text{ V}$ ;  $V_{out} = 1.5\text{ V}$ )

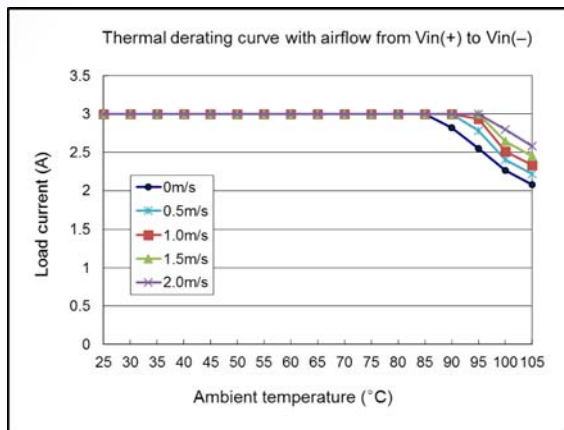

Thermal derating with airflow from  $V_{in}(+)$  to  $V_{in}(-)$   
 ( $V_{in} = 3.3\text{ V}$ ;  $V_{out} = 1.2\text{ V}$ )

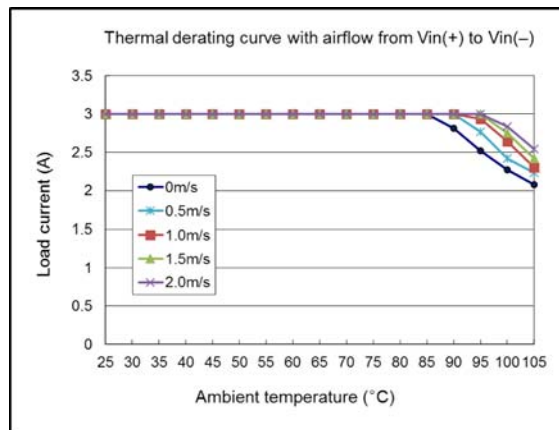

Thermal derating with airflow from  $V_{in}(+)$  to  $V_{in}(-)$   
 ( $V_{in} = 3.3\text{ V}$ ;  $V_{out} = 1.0\text{ V}$ )

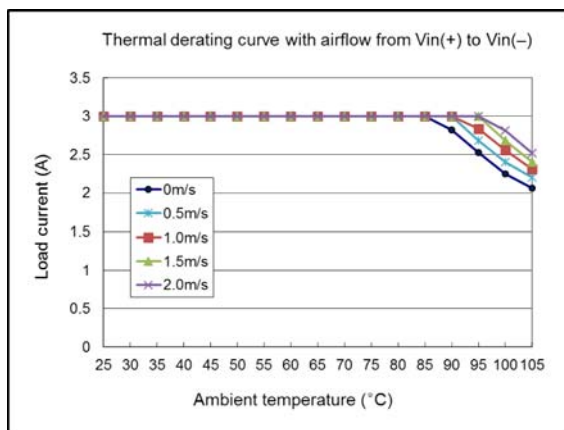

Thermal derating with airflow from  $V_{in}(+)$  to  $V_{in}(-)$   
 ( $V_{in} = 3.3\text{ V}$ ;  $V_{out} = 0.9\text{ V}$ )

Thermal derating with airflow from  $V_{in}(+)$  to  $V_{in}(-)$   
 ( $V_{in} = 3.3\text{ V}$ ;  $V_{out} = 0.8\text{ V}$ )

### 3.4 Turn-on/Turn-off

Conditions:  $T_A = 25^\circ\text{C}$ ,  $V_{in} = 3.3\text{ V}$ ,  $V_{out} = 1.2\text{ V}$

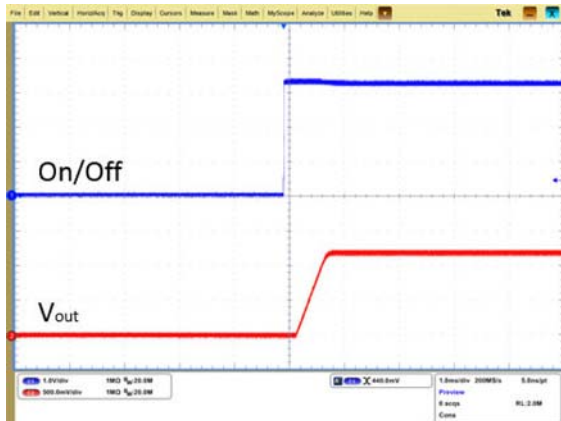

Startup from On/Off

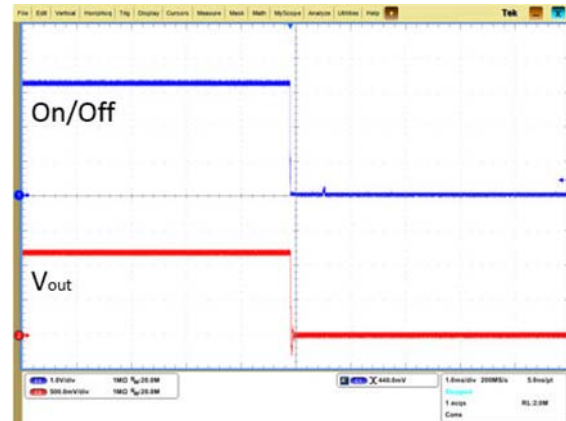

Shutdown from On/Off

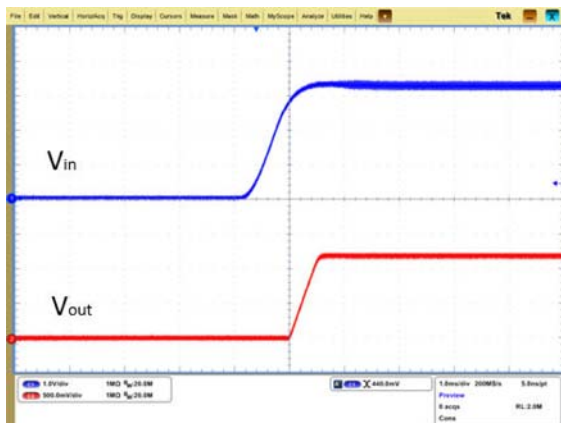

Startup by power-on

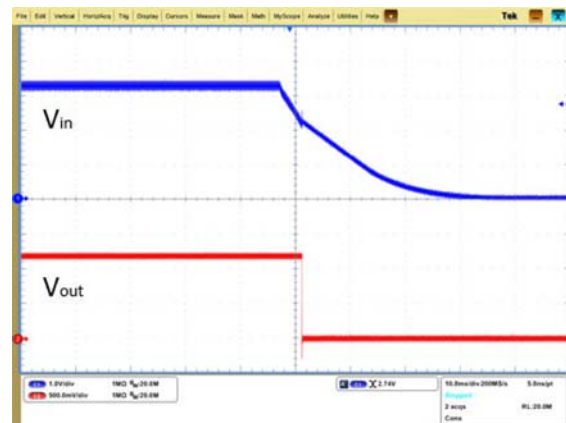

Shutdown by power-off

### 3.5 Output voltage ripple

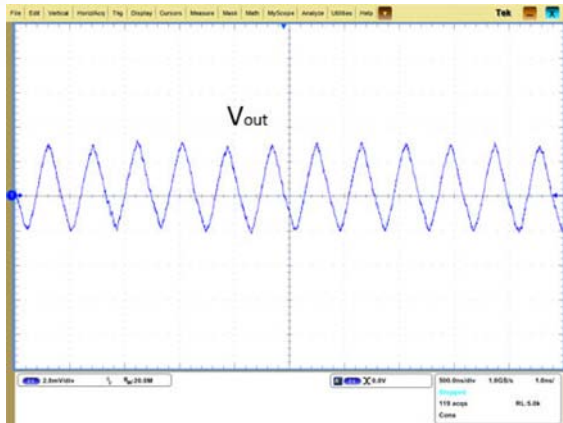

Output voltage ripple (for points B and C in the test set-up diagram,  $V_{in} = 3.3\text{ V}$ ,  $V_{out} = 1.2\text{ V}$ ,  $I_{out} = 3\text{ A}$ )

### 3.6 Input reflected ripple current

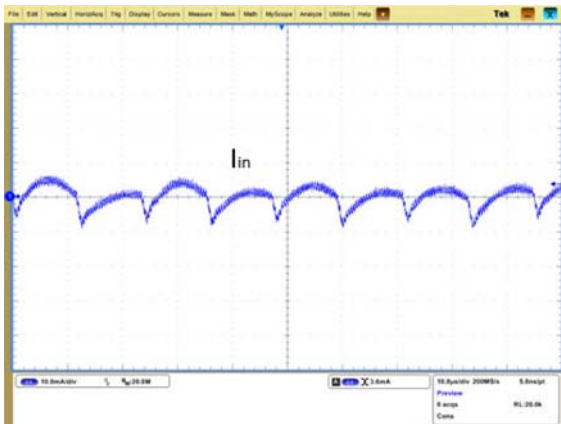

Input reflected ripple current (for point A in the test set-up diagram,  $V_{in} = 3.3\text{ V}$ ,  $V_{out} = 1.2\text{ V}$ ,  $I_{out} = 3\text{ A}$ )

### 3.7 Output Voltage Dynamic Response

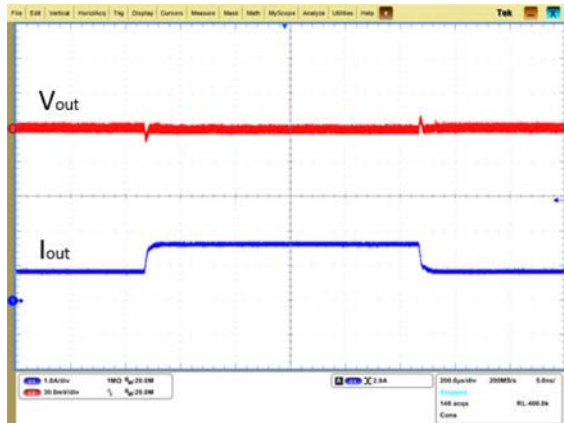

Load: 25% - 50% - 25%, di/dt = 5 A/ $\mu$ s

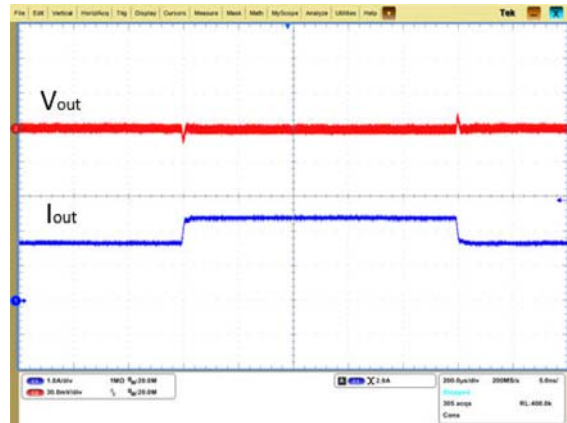

Load: 50% - 75% - 50%, di/dt = 5 A/ $\mu$ s



# 4 Control Features

## 4.1 Remote On/Off

EN Pin Level	Status
Low level	Off
High level	On

It is recommended that the On/Off pin be controlled with an open collector transistor or similar device.

Figure 4-1 Circuit configuration for On/Off function

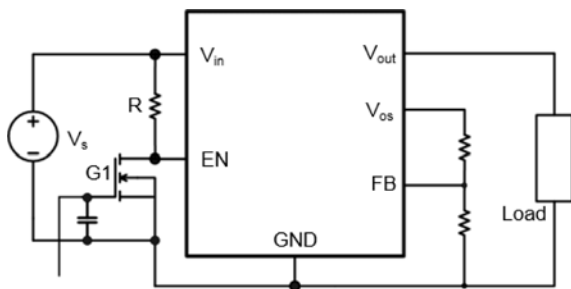

## 4.2 Output Voltage Trim

The output voltage can be adjusted by connecting an external resistor between the Trim (FB) pin and the GND pin.

Figure 4-2  $R_{trim}$  external connections

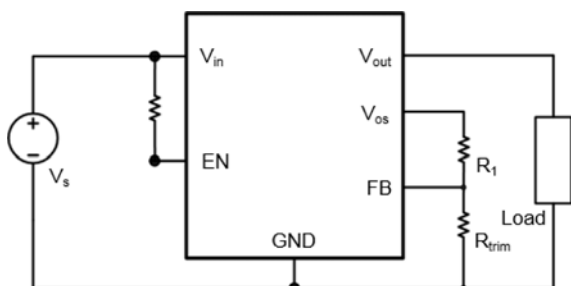

Relationship between  $R_{trim}$  and  $V_{out}$ :

$$R_{trim} = \left[ \frac{16}{V_{out} - 0.8} \right] k\Omega$$

#### NOTE

The output voltage varies depending on  $R_{trim}$ . Note that the trim resistor tolerance directly affects the output voltage accuracy.

The following table describes the mapping between  $V_{out}$  and  $R_{trim}$ .

$V_{out}$ (V)	$R_{trim}$ (k $\Omega$ )
0.8	-
0.9	160.0000
1.0	80.0000
1.1	53.3300
1.2	40.0000
1.5	22.8570
1.8	16.0000
2.5	9.4117
3.3	6.4000
3.7	5.5170

## 4.3 Power Good Signal (PG)

The power good (PG) signal is pulled up to  $V_{in}$  or a fixed level not exceeding 6 V through a resistor when in use. If the PG function is not required, the pin is left open. The configuration diagram of PG is shown in [Figure 4-3](#).

**Figure 4-3** Configuration diagram of PG

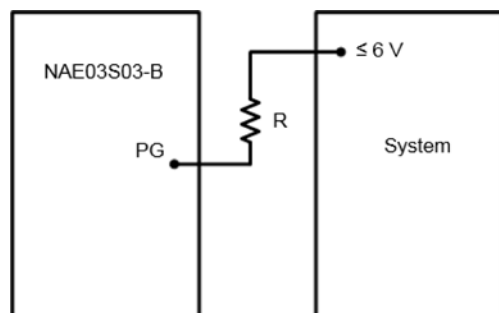

## 4.4 Voltage Tracking (SS)

An external capacitor connected to SS pin sets the internal reference voltage rise time.

# 5 Protection Features

---

## Input Undervoltage Protection

The converter will shut down if the input voltage drops below the undervoltage protection threshold. The converter will start to work again if the input voltage reaches the input undervoltage recovery threshold. For the hysteresis, see the Protection characteristics.

## Output Overcurrent Protection

The converter equipped with current limiting circuitry can provide protection from an output overload or short circuit condition. If the output current exceeds the output overcurrent protection set point, the converter enters hiccup mode. When the fault condition is removed, the converter will automatically restart.

## Overtemperature Protection

A temperature sensor on the converter senses the average temperature of the converter. It protects the converter from being damaged at high temperatures. When the temperature exceeds the overtemperature protection threshold, the output will shut down. It will allow the converter to turn on again when the temperature of the sensed location falls by the value of the overtemperature protection hysteresis.

# 6 Qualification Testing

Precondition test required for test items 1 - 8: Visual inspection → Electrical test → SAT → Bake (125°C, 24 h) → Moisture soaking → Reflow (3 cycles, 260°C) → Visual inspection → Electrical test → SAT.

No.	Test Item	Units	Condition
1	High temperature storage life test	77/3 lots	125°C, 1000 h
2	High temperature storage life test (extreme test)	77	150°C, 1000 h
3	Unbiased highly accelerated stress test	77/3 lots	130°C, 85% RH, 96 h
4	Thermal shock	77/3 lots	1000 temperature cycles between - 55°C and +125°C, 200/500/700/1000 cycles with no power on
5	Temperature humidity bias	77/3 lots	85°C, 85% RH, 1200 operating hours
6	High temperature operating life test	77/3 lots	Rated input voltage, ambient temperature 100°C, 1000 operating hours, thermal test point at 115°C for PCB or inductor
7	Power and temperature cycling test	77/3 lots	Rated input voltage, thermal test point at 115°C for PCB or inductor, ambient temperature between - 40°C and +100°C, temperature change rate between 10°C/min and 15°C/min, 1000 cycles under 50% load
8	Highly accelerated life test	8/3 lots	Low temperature limit: - 60°C; high temperature limit: 110°C; vibration limit: 40 G; temperature slope: 40°C per minute; vibration frequency range: 20 - 2000 Hz
9	ESD	3	HBM 2000 V, CDM 500 V
10	Autoclave	25	121°C, 100% RH, 1 bar above atmosphere, 96 h
11	Salt fog	16	Classification C for 5 years: 2% salt fog, 90% RH, 35°C, 20 days

No.	Test Item	Units	Condition
12	Moisture and dust	16	Dust accumulated for 6 days (30 mg/m <sup>3</sup> ), steady damp heat (95% RH, 40°C) for 12 days, cyclic damp heat for 4 days
13	Thermal cycle test	32	- 40°C to 125°C, ramp rate 10°C–15°C/min, dwell time 15 minutes, 1 hour/cycle
14	Shadow moire	3	Temperature range: 25°C–300°C
15	Solderability	32	<ul style="list-style-type: none"><li>● Steam aging: 1 atmospheric pressure for 8 h or baking at 155°C、4 h±15 mins,</li><li>● Assemble the device onto PCB by reflow soldering</li></ul>

# 7 Thermal Consideration

---

## Thermal Test Point

Sufficient airflow should be provided to ensure reliable operating of the converter. Therefore, thermal components are mounted on the top surface of the converter to dissipate heat to the surrounding environment by conduction, convection, and radiation. Proper airflow can be verified by measuring the temperature at the surface of the converter.

**Figure 7-1** Thermal test point

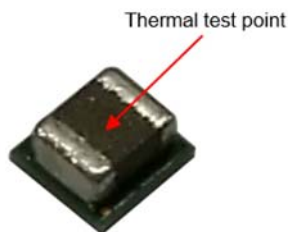

## Power Dissipation

The converter power dissipation is calculated based on efficiency. The following formula reflects the relationship between the consumed power ( $P_d$ ), efficiency ( $\eta$ ), and output power ( $P_o$ ):  $P_d = P_o (1 - \eta)/\eta$

# 8 Encapsulation Size Diagram

Unit of measurement: mm [in.]

Figure 8-1 Encapsulation Size Diagram

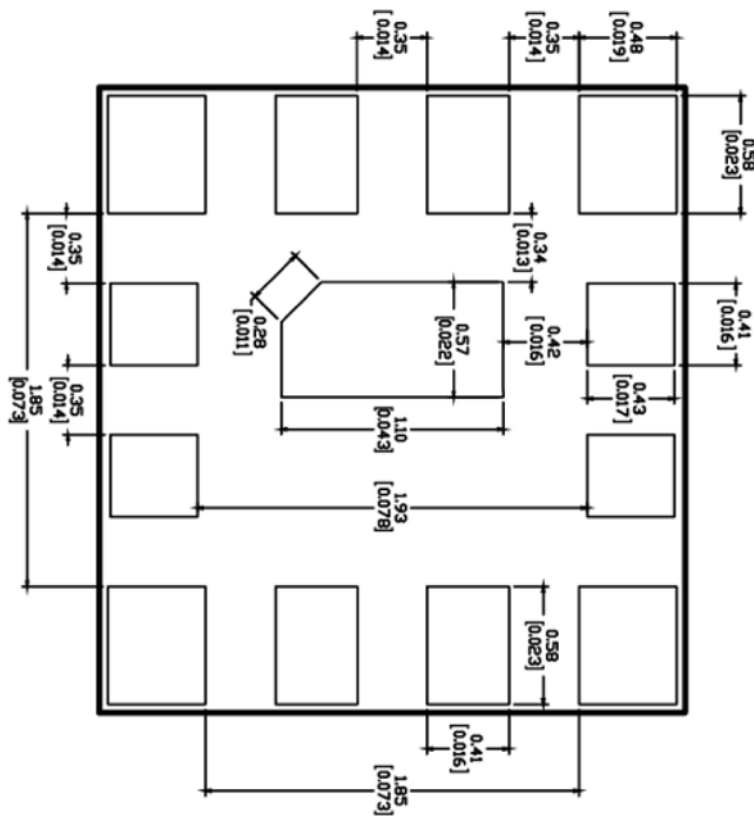



# 9 Package Information

The converter is supplied in tape and reel packaging. The following figure shows the tape dimensions.

Unit of measurement: mm

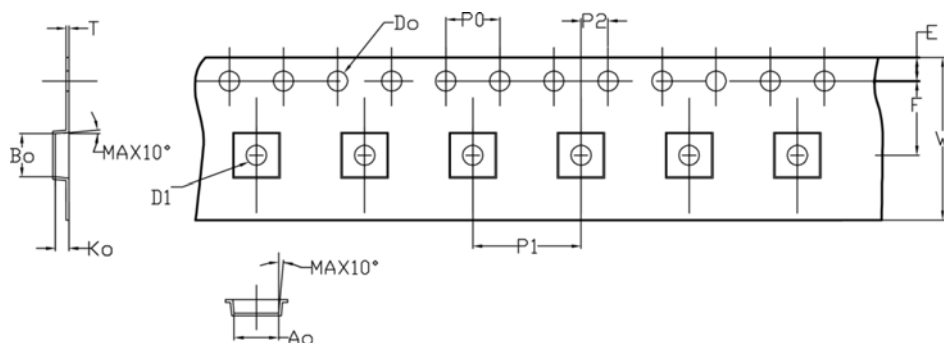

<b>Item</b>	W	A0	B0	K0	P0	E
<b>Specific ations</b>	12.00±0.30	3.10±0.10	3.25±0.10	1.70±0.10	4.00±0.10	1.75±0.10
<b>Item</b>	F	D0	D1	P1	P2	T
<b>Specific ations</b>	5.50±0.05	1.50 <sup>+0.10</sup> <sub>-0.00</sub>	1.50 <sup>+0.10</sup> <sub>-0.00</sub>	8.00±0.10	2.00+0.05	0.30+0.05

#### NOTE

- Carrier camber does not exceed 1 mm in 250 mm.
- Cumulative tolerance of 10 sprocket hole pitch: ± 0.2 mm
- Material: ABS

# 10 Mechanical Consideration

## Surface Mount Information

The converter uses a PSiP structure and is designed for a fully automated assembly process.

The flat surface of the label on the large inductor can be the patch mounting surface. The converter weight can be borne by a standard surface mount device (SMD). For most SMDs, the converter is heavy, and mounting on the capacitor surface will cause deviation. The solution is to optimize the model and size of the suction nozzle and increase the mounting speed and vacuum pressure.

The label meets all the requirements for surface mount processing, as well as safety standards, and is able to withstand reflow temperatures of up to 300°C. The label also carries product information such as product code and manufacturing date.

## Soldering

The converter supports reflow soldering techniques. Wave soldering and hand soldering are not allowed. During the reflow process, the peak temperature must not exceed 260°C at any time.

Figure 10-1 Recommended reflow profile using lead-free solder

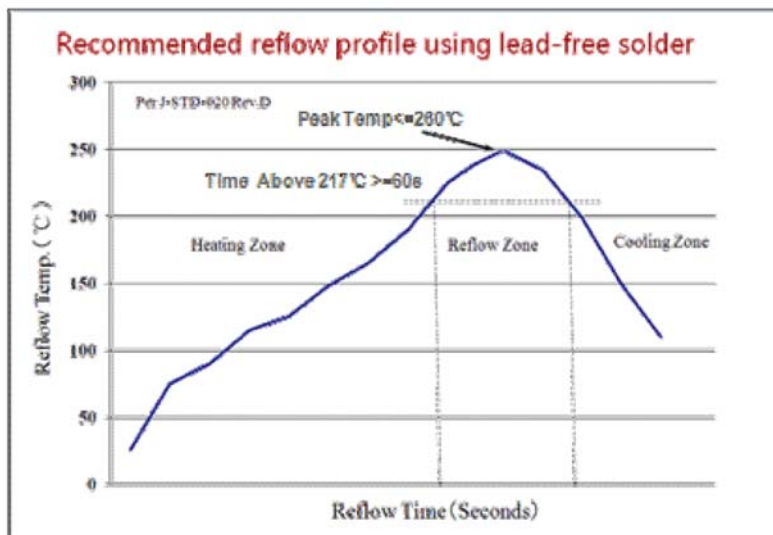

#### Moisture Resistance Requirements

Store and transport the converter as required by the MSL rating 3 specified in the IPC/JEDEC J-STD-033.

The surface of a soldered converter must be clean and dry. Otherwise, the assembly, test, or even reliability of the converter will be negatively affected.



**Copyright © Huawei Technologies Co., Ltd. 2019. All rights reserved.**

No part of this document may be reproduced or transmitted in any form or by any means without prior written consent of Huawei Technologies Co., Ltd.

#### **Trademarks and Permissions**



HUAWEI and other Huawei trademarks are trademarks of Huawei Technologies Co., Ltd.

All other trademarks and trade names mentioned in this document are the property of their respective holders.

#### **Notice**

The purchased products, services and features are stipulated by the contract made between Huawei and the customer. All or part of the products, services and features described in this document may not be within the purchase scope or the usage scope. Unless otherwise specified in the contract, all statements, information, and recommendations in this document are provided "AS IS" without warranties, guarantees or representations of any kind, either express or implied.

The information in this document is subject to change without notice. Every effort has been made in the preparation of this document to ensure accuracy of the contents, but all statements, information, and recommendations in this document do not constitute a warranty of any kind, express or implied.

**Huawei Technologies Co., Ltd.**

Huawei Industrial Base  
Bantian, Longgang  
Shenzhen 518129  
People's Republic of China

[www.huawei.com](http://www.huawei.com)